

INSTALLATION AND OPERATING INSTRUCTIONS

CEILING / WALL VENTILATION FAN

READ AND SAVE THESE INSTRUCTIONS

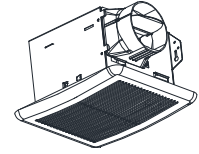

General Safety Information

1. Make sure that the electric service supply voltage is AC 120V, 60Hz.
2. Follow all local electrical and safety codes, as well as the National Electrical Code (NEC) and the Occupational Safety and Healthy Act (OSHAAct).
3. Always disconnect the power source before working on or near the ventilating fan, motor or junction box.
4. Protect the power cord from sharp edges, oil, grease, hot surfaces, chemicals or other objects.
5. Do not kink the power cord.
6. Do not install the unit where ducts are configured as shown in Fig. A.
7. Provide suction parts with proper ventilation.
8. This unit is UL listed for use over a bathtub or shower when installed in a GFCI protected branch circuit.

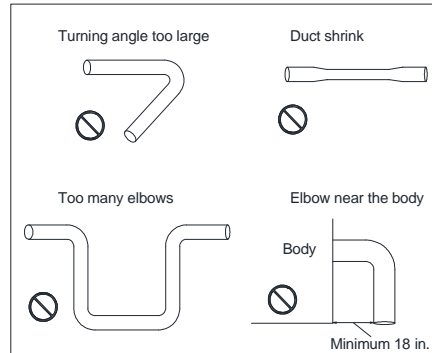

Fig. A

CAUTION

1. For General Ventilating Use Only. Do Not Use To Exhaust Hazardous Or Explosive Materials And Vapors.
2. Not for use in cooking area. (Fig. B)
3. This product must properly connect to the grounding conductor of the supply circuit.
4. To reduce the risk of injury to persons, install the fan at least 8.2 feet (2.5m) above the floor.

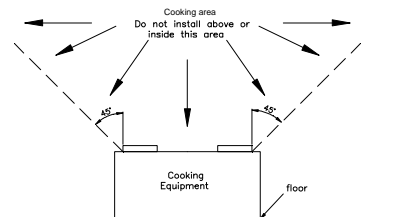

Fig. B

WARNING

TO REDUCE THE RISK OF FIRE, ELECTRIC SHOCK, OR INJURY TO PERSONS, OBSERVE THE FOLLOWING:

1. Use this unit only in the manner intended by the manufacturer. If you have any questions, contact the manufacturer.
2. Before servicing or cleaning the unit, switch power off at service panel and lock the service disconnecting means to prevent power from being switched on accidentally. When the service disconnecting means cannot be locked, securely fasten a prominent warning device, such as a tag, to the service panel.
3. Installation work and electrical wiring must be done by qualified person(s) in accordance with all applicable codes and standards, including fire-rated construction.
4. Sufficient air is needed for proper combustion and exhausting of gases through the flue (chimney) of fuel burning equipment to prevent back drafting. Follow the heating equipment manufacturer's guideline and safety standards such as those published by the National Fire Protection Association (NFPA), and the American Society for Heating, Refrigeration and Air Conditioning Engineers (ASHRAE), and the local code authorities.
5. When cutting or drilling into wall or ceiling, do not damage electrical wiring and other hidden utilities.
6. Ducted fans must always be vented to the outdoors.
7. If this unit is to be installed over a tub or shower, it must be marked as appropriate for the application and be connected to a GFCI (Ground Fault Circuit Interrupter) – protected branch circuit.
8. Do not use this unit with any other solid-state control device. Solid-state controls devices may cause harmonic distortion, which can cause a motor humming noise.
9. **NEVER** place a switch where it can be reached from a tub or shower.
10. Not to be installed in a ceiling thermally insulated to a value greater than R50. (This is required for installation in Canada only).

INSTALLATIONS

Proper insulation around the fan to minimize building heat loss and gain. 4" circular duct is recommended for installation. The ducting from this fan to the outside of building has a strong effect on the air flow, noise and energy use of the fan. Use the shortest, straightest duct routing possible for best performance, and avoid installing the fan with smaller ducts than recommended. Insulation around the ducts can reduce energy loss and inhibit mold growth. Fans installed with existing ducts may not achieve their rated air flow.

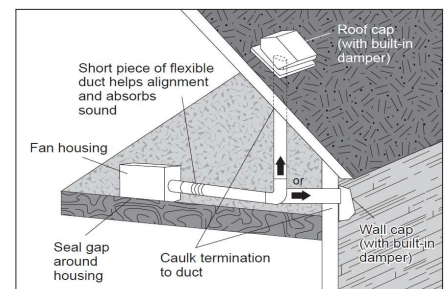



Install with wood frame

Model No.	ITG100
Install Dim. (Inch)	7-1/2 x 7-1/4

1. Remove motor plate from housing by removing three screws. (Fig. C)
2. Remove wiring cover from housing by pulling straight out. Choose a hole and use a slotted screwdriver to remove it. (Fig. D)
3. Follow all local electrical and safety codes. **NEVER** place a switch where it can be reached from a tub or shower. Connect wires as shown in wiring diagrams. (Fig. E)
4. Using wire nuts (not provided), connect house power cable to ventilating fan wires. 14 AWG (2.1 mm²) is the smallest conductor that shall be used for branch-circuit wiring. (Fig. F)
5. Insert the duct into the duct connector and tape all ductworks connection to make them secure and airtight. Install the duct with a gradient 1°-2° to the outside. (Fig. G)
6. **New installation prior to finishing the ceiling or wall:** Insert the fan between joists. Make sure the fan body is level and perpendicular with the joist. (Fig. H)
7. **Replacement installation:** After making electrical and ductwork connections (see steps 2-5), nail housing in place. Drive nails through the housing where indicated by arrows. (Fig. I)
8. **New installation in an existing ceiling or wall:** Bend tabs outward 90° Use a screw driver if desired) and position housing so that tabs rest against bottom edge of joists (or front of stud). Nail housing to joist or stud using four nails to ensure a solid, quiet installation. Ceiling installations: Tabs on opposite side of housing can be bent outward to rest on top of 1/2" ceiling material and provide extra stability. (Fig. J)
9. Plug in the motor and locking the fan body back by using three screws. (Fig. C)
10. Squeeze grille springs together and insert springs into slots in motor plate. Push grille up against ceiling or wall. When the power on,

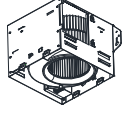
SUPPLIED ACCESSORIES

Part name	Appearance	Quantity
Grille		1
Fan & Housing		1
4" Duct		1
Screw (M4x12)		3

check for abnormal vibration or sound. Insert the mounting springs into the slots and mount the grille to the body. (Fig. K)

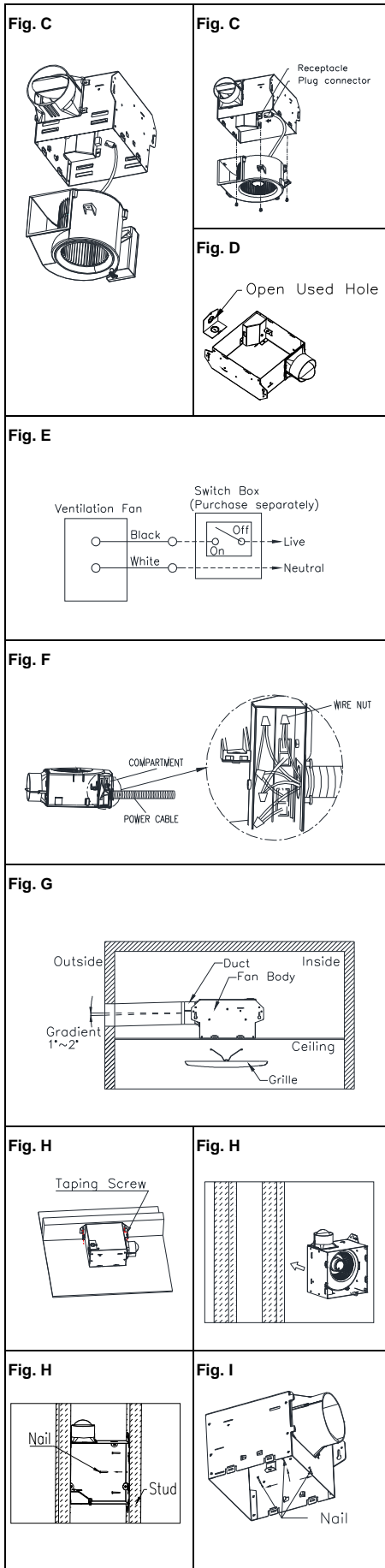

OPERATION

Single speed control mode: Turn the power switch to operate ON/OFF.

MAINTENANCE:

Disconnect the power source before working on the unit. Routine maintenance must be done every year.

CAUTION:

1. Never use gasoline, benzene, thinner or any other such chemicals for cleaning the ventilating fan.
2. Do not allow water to enter the motor.
3. Do not soak resin parts in water over 140 °F (60°C).

CLEANING:

1. Pull down the spring to remove the grille.
2. Wash and clean the grille. (Use non-abrasive kitchen detergent and wipe dry with a new cloth.)
3. Remove dust and dirt from the ventilating fan using a vacuum cleaner.
4. Using a cloth dampened with kitchen detergent, remove any dirt from the ventilating fan. Wipe dry with a new cloth.
5. Replace the grille.

SPECIFICATIONS

Model No.	Voltage (V)	Frequency (Hz)	Air Flow @ 0.1"SP (CFM)	Power @ 0.1"SP (W)	Max Current (Amps)	Weight (lb.)	Note
ITG100	120	60	100	17.0	0.33	6.61	

Note: Design and specifications are subject to change without notice.

DIMENSIONS

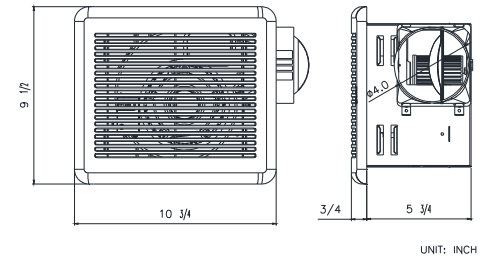

WARRANTY

DELTA ELECTRONICS THREE YEAR LIMITED WARRANTY

Delta Electronics Inc. ("Delta Electronics") warrants to the original consumer purchaser in the USA that the Breez ventilation fan products will be free from defects in material or workmanship. This warranty is limited to three (3) years from the original date of purchase.

Limitations and Exclusions

1. During the warranty period, a replacement for any defective product will be supplied free of charge for installation by the consumer. The warranty provided herein does not cover charges for labor or other costs incurred in the troubleshooting, repair, removal, and installation service.
2. All returns of defective parts or products must include the product model number, and must be made through an authorized Delta Electronics distributor. Authorized returns must be shipped prepaid. Repaired or replacement products will be shipped by Delta Electronics F.O.B. shipping point.
3. Delta Electronics shall not be liable for any indirect, incidental, consequential, punitive, or special damages arising out of or in connection with products use or performance, regardless of the form of action whether in contract, tort (including negligence), strict product liability or otherwise.
4. This warranty does not extend to fluorescent lamp starters and tubes.
5. The warranty does not cover if user does not comply with manufacture's installation manual.
6. To qualify for warranty service, you must notify Delta Electronics at the address or telephone number below.
7. Delta Electronics shall have no liability to the original owner-user with respect to any defect caused by abuse, misuse, neglect, improper transportation or storage, improper testing, improper installation, improper operation, improper use, improper maintenance, improper repair, improper alteration, improper modification, tampering or accident of products or parts thereof, or unusual deterioration or degradation of products or parts thereof due to a physical environment beyond the requirements of products' specifications.

Address: 46101 Fremont Boulevard, Fremont, CA 94538
 US Toll Free Number: 1-888-979-9889